

CANE

14" ROUGH-IN TANK
PLOMBERIE BRUTE DE 14 PO

- 4724BFT Lined Tank / Réservoir isolé
- 4724BFTU Unlined Tank / Réservoir non-isolé

6.0LPF / 1.6GPF



ILLUSTRATED PARTS LIST | LISTE DE PIÈCES ILLUSTRÉE

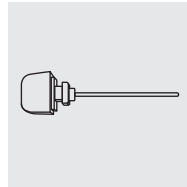
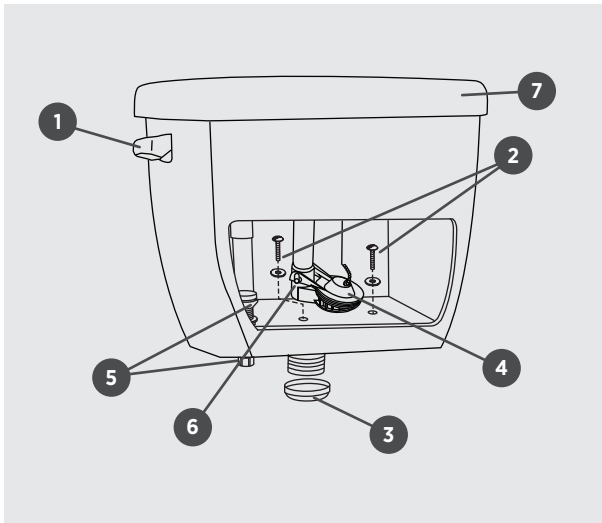

1 | PB-T LEVER-RT-A5601
HANDLE
BOUTON

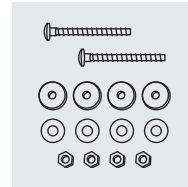

2 | PB-CONTRAC TANK-HW
TANK HARDWARE
MATÉRIEL DE RÉSERVOIR

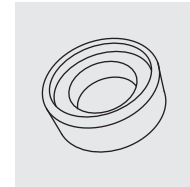

3 | PB-TGASK 2IN-R610124
GASKET
JOINT

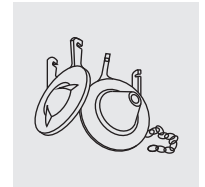

4 | PB-FLAPPER 2IN-RT-CR
FLAPPER
CLAPET

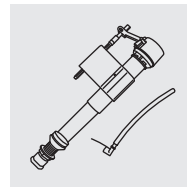

5 | PB-FILLV-H-A2002
FILL VALVE
ROBINET DE REMPLISSAGE

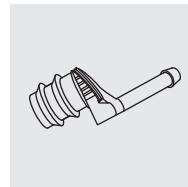

6 | PB-FLUSHV-H-P2002
FLUSH VALVE
ROBINET DE CHASSE

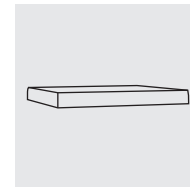

7 | PBC-4724BFV-SW TLID
TANK LID
COUVERCLE DU RÉSERVOIR