

# CAYLA

**TWO PIECE HIGH EFFICIENCY TOILET**  
**TOILETTE DEUX PIÈCES HAUTE EFFICACITÉ**

- **4782BOV** Bowl / Cuvette
- **4781BOV** Lined Tank / Réservoir isolé
- **4781BOVU** Unlined Tank / Réservoir non-isolé

**4.8LPF / 1.28GPF**



## ILLUSTRATED PARTS LIST | LISTE DE PIÈCES ILLUSTRÉE

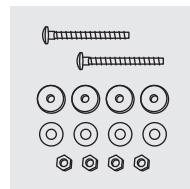
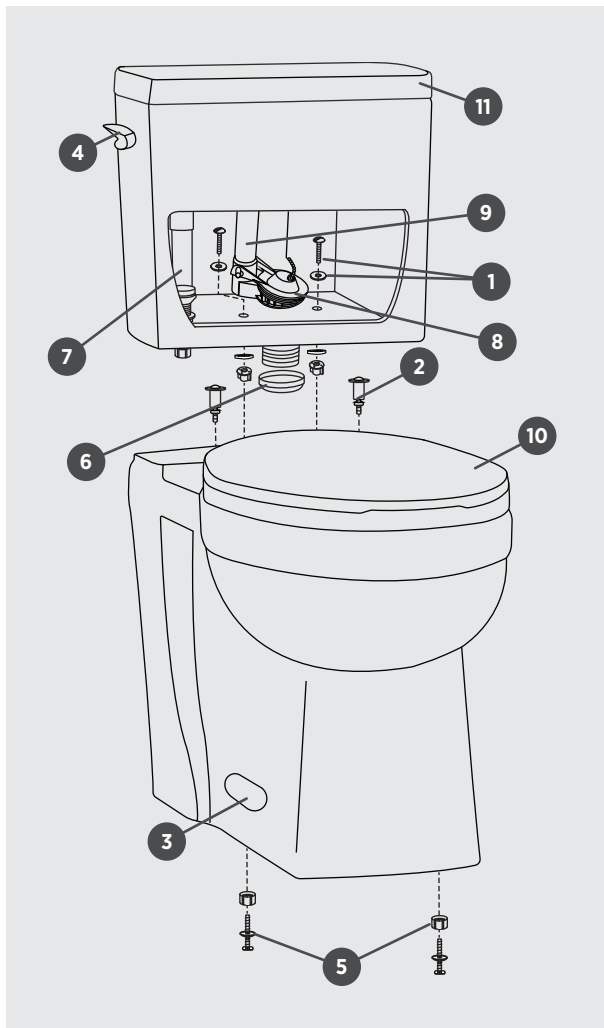

**1 |**  
**PB-CONTRAC TANK-HW**  
**TANK HARDWARE**  
**MATÉRIEL DE RÉSERVOIR**

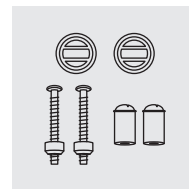

**2 |**  
**PB-EXPANSION HW-MT9**  
**TOILET SEAT HARDWARE**  
**MATÉRIEL DE SIÈGE DE TOILETTE**

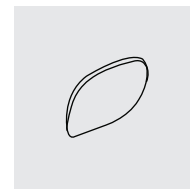

**3 |**  
**PB-OVAL SIDE CAP**  
**OVAL SIDE CAPS**  
**CAPUCHONS À CÔTÉ OVALE**

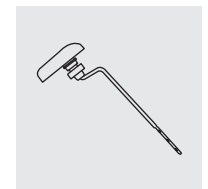

**4 |**  
**PBC-TANKLEVER-B0079**  
**HANDLE**  
**BOUTON**

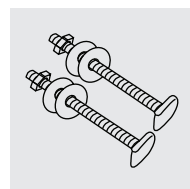

**5 |**  
**PB-TOILET FLOORBOLTS**  
**FLOOR BOLTS**  
**BOULONS À PLANCHE**

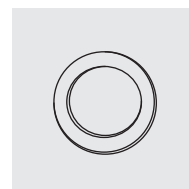

**6 |**  
**PB-TOILET GASKET 3IN**  
**GASKET**  
**JOINT**

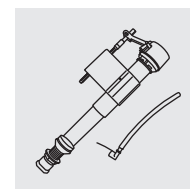

**7 |**  
**PB-FILLV-H-A2002**  
**FILL VALVE**  
**ROBINET DE REMPLISSAGE**

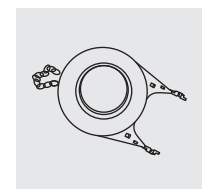

**8 |**  
**PB-FLAPPER-H-3IN**  
**FLAPPER**  
**CLAPET**

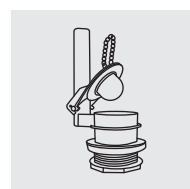

**9 |**  
**PB-FLUSHV-H-P20201**  
**FLUSH VALVE**  
**ROBINET DE CHASSE**

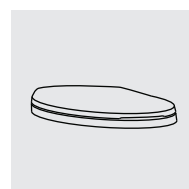

**10 |**  
**PB-SC TS-H-S6071**  
**TOILET SEAT**  
**SIÈGE DE TOILETTE**

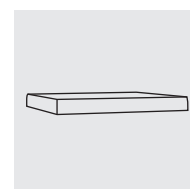

**11 |**  
**PB-4781BOV-TANK LID**  
**TANK LID**  
**COUVERCLE DU RÉSERVOIR**