

TL-2100-WL-RONA

ONE PIECE HIGH EFFICIENCY DUAL FLUSH TOILET
TOILETTE UNE PIÈCE HAUTE EFFICACITÉ

□ TL-2100-WL-RONA Lined Tank / Réservoir isolé

6.0LPF / 1.6GPF OR (OU) 4.1LPF / 1.1GPF



ILLUSTRATED PARTS LIST | LISTE DE PIÈCES ILLUSTRÉE

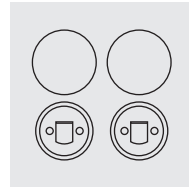
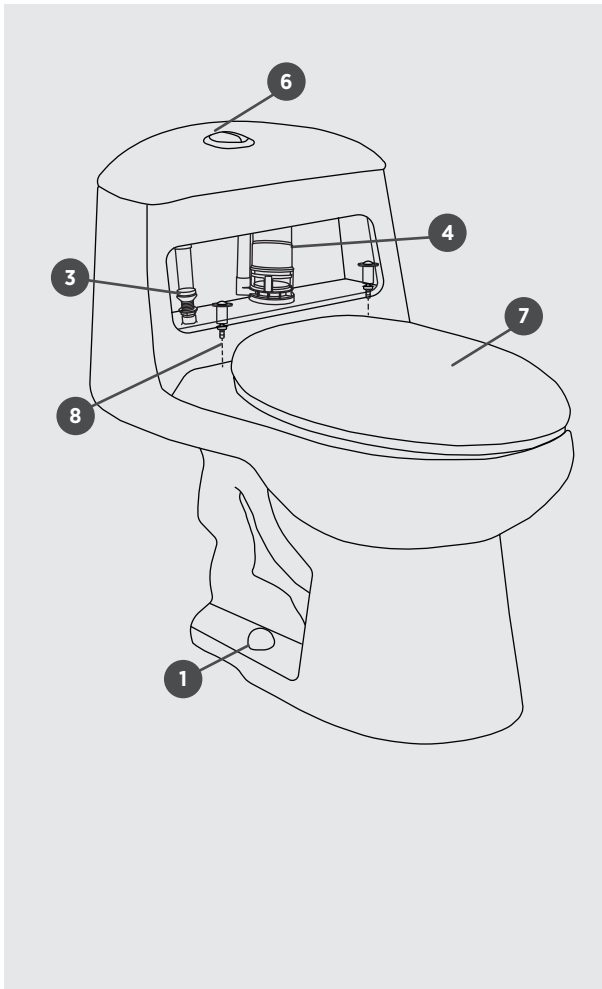

1 | PB-TBOLT CAP STD W
BOLT CAPS
BOUCHONS

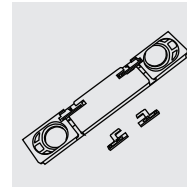

2 | PB-QUICK R-WD11500S
QUICK RELEASE
LIBÉRATION RAPIDE

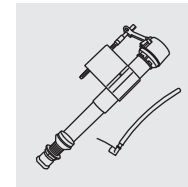

3 | PB-FILLV-H-A2002
FILL VALVE
ROBINET DE REMPLISSAGE

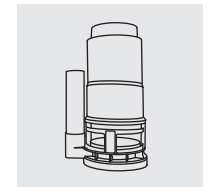

4A | PB-FLUSHV1-H-P2212
FLUSH VALVE
ROBINET DE CHASSE

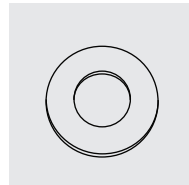

4B | PB-FLUSHV GASKET-H
FLUSH VALVE GASKET
ROBINET DE CHASSE JOINT



5 | PB-PBUTTONSTEM-4IN
PUSH BUTTON ROD
BARRE BOUTON-POUSSOIR

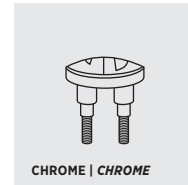

6 | PB-PBUTTON-H-A36131
PUSH BUTTON
BOUTON-POUSSOIR

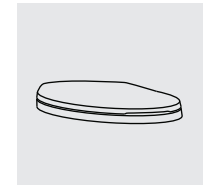

7 | PB-T SEAT-WD11500S
TOILET SEAT
SIÈGE DE TOILETTE

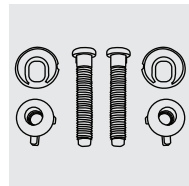

8 | PB-T SEAT HWWD11500S
TOILET SEAT HARDWARE
MATÉRIEL SIÈGE DE TOILETTE