

TL-8267-WL-RONA

TWO PIECE HIGH EFFICIENCY DUAL FLUSH TOILET
TOILETTE DEUX PIÈCES HAUTE EFFICACITÉ

□ TL-8267-WL-RONA Lined Tank / Réservoir isolé



6.0LPF / 1.6GPF OR (OU) 4.1LPF / 1.1GPF

ILLUSTRATED PARTS LIST | LISTE DE PIÈCES ILLUSTRÉE

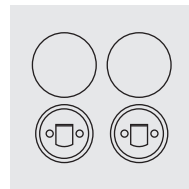
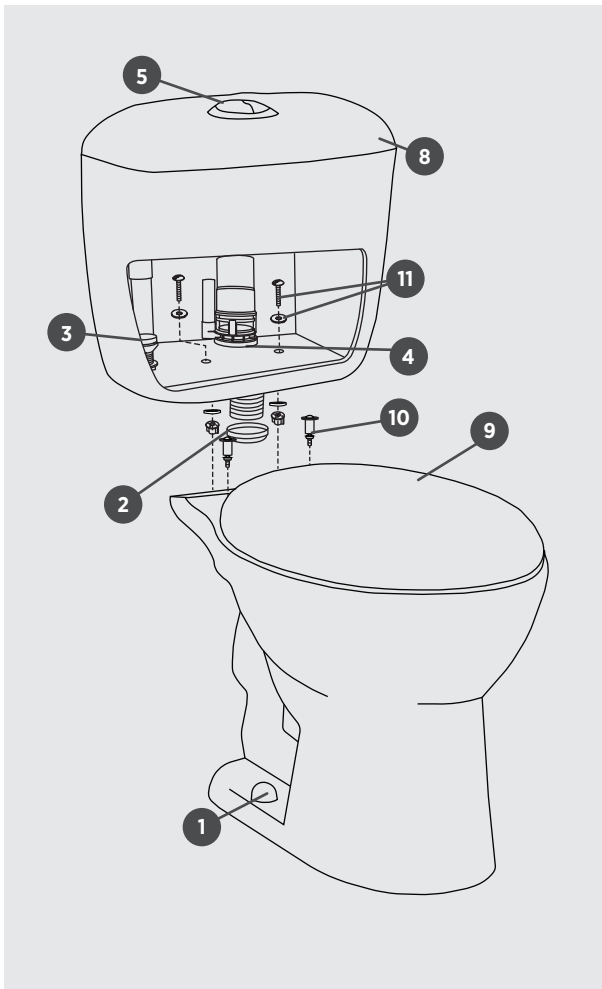

1 | PB-T BOLT CAP STD W
BOLT CAPS
BOUCHONS

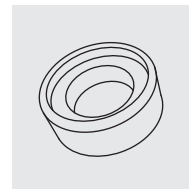

2 | PB-TGASK 2IN-R610124
GASKET
JOINT

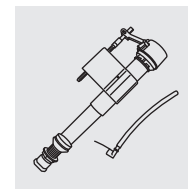

3 | PB-FILLV-H-A2002
FILL VALVE
ROBINET DE REMPLISSAGE

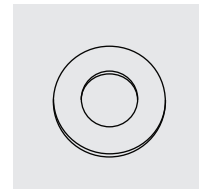

4A | PB-FLUSHV GASKET-H
FLUSH VALVE GASKET
ROBINET DE CHASSE JOINT

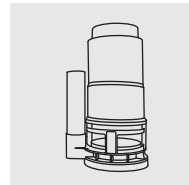

4B | PB-FLUSHV-RT-A2412
FLUSH VALVE
ROBINET DE CHASSE

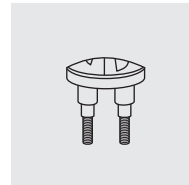

5 | PB-PBUTTON-H-A36131
PUSH BUTTON
BOUTON-POUSSOIR

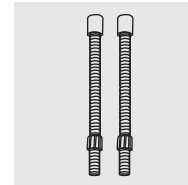

6 | PB-PBUTTONSTEM-4IN
PUSH BUTTON ROD
BARRE BOUTON-POUSSOIR

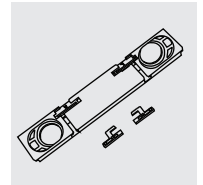

7 | PB-QUICK R-WD11500S
QUICK RELEASE
LIBÉRATION RAPIDE

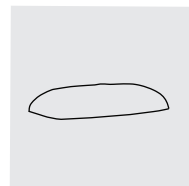

8 | PB-TL8267-TANK LID
TOILET LID
COUVERCLE DU RÉSERVOIR

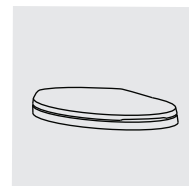

9 | PB-T SEAT-WD11500S
TOILET SEAT
SIÈGE DE TOILETTE

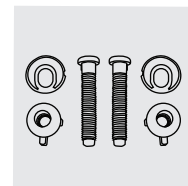

10 | PB-T SEAT HWWD11500S
TOILET SEAT HARDWARE
MATÉRIEL SIÈGE DE TOILETTE

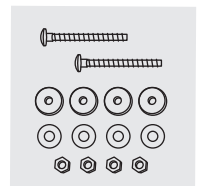

11 | PB-TOILET TANK HW
TANK HARDWARE
MATÉRIEL DE RÉSERVOIR