

TL-8267-WL1-UHD

TWO PIECE HIGH EFFICIENCY DUAL FLUSH TOILET
TOILETTE DEUX PIÈCES HAUTE EFFICACITÉ

□ TL-8267-WL1-UHD Lined Tank / Réservoir isolé



6.0LPF / 1.6GPF OR (OU) 4.1LPF / 1.1GPF

ILLUSTRATED PARTS LIST | LISTE DE PIÈCES ILLUSTRÉE

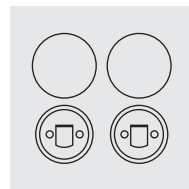
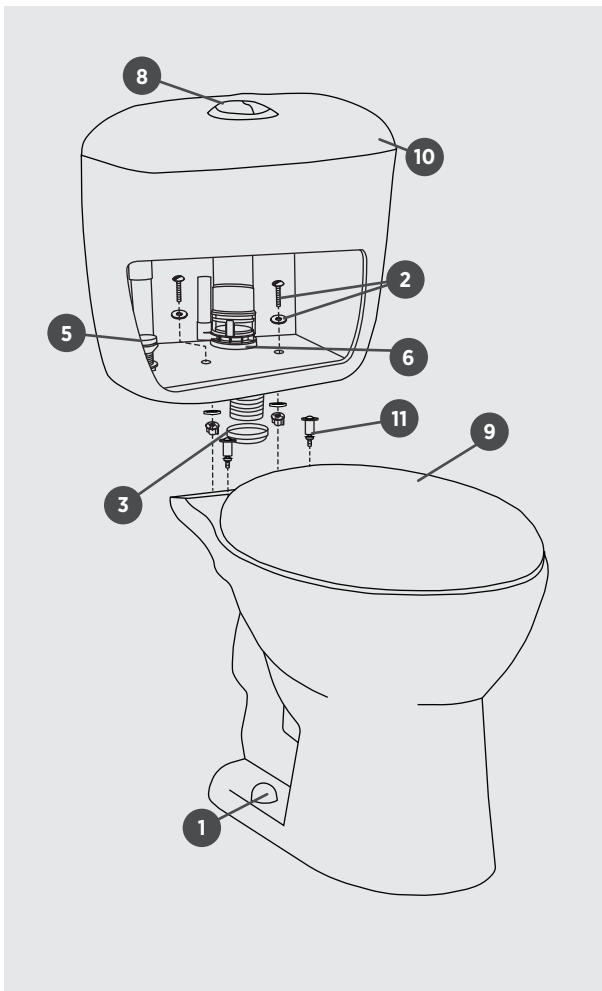

1 | PB-TBOLT CAP STD W
BOLT CAPS
BOUCHONS

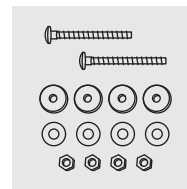

2 | PB-TOILET TANK HW
TANK HARDWARE
MATÉRIEL DE RÉSERVOIR

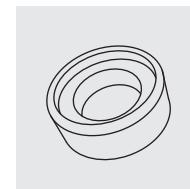

3 | PB-TGASK 2IN-R610124
GASKET
JOINT

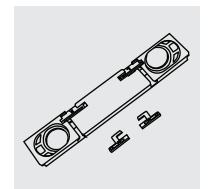

4 | PB-QUICK R-WD11500S
QUICK RELEASE
LIBÉRATION RAPIDE

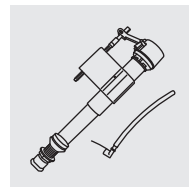

5 | PB-FILLV-H-A2002
FILL VALVE
ROBINET DE REMPLISSAGE

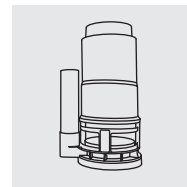

6A | PB-FLUSHV-RT-A2412
FLUSH VALVE
ROBINET DE CHASSE

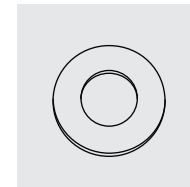

6B | PB-FLUSHV GASKET-H
FLUSH VALVE GASKET
ROBINET DE CHASSE JOINT

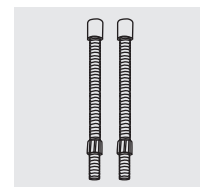

7 | PB-PBUTTONSTEM-4IN
PUSH BUTTON ROD
BARRE BOUTON-POUSSOIR

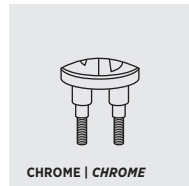

8 | PB-PBUTTON-H-A36131
PUSH BUTTON
BOUTON-POUSSOIR

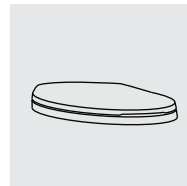

9 | PB-T SEAT-WD11500S
TOILET SEAT
SIÈGE DE TOILETTE

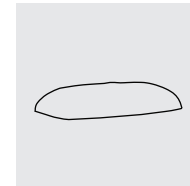

10 | PB-TL8267 TANK LID
TANK LID
COUVERCLE DU RÉSERVOIR

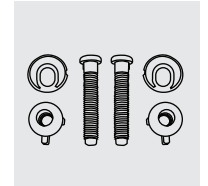

11 | PB-T SEAT HWWD11500S
TOILET SEAT HARDWARE
MATÉRIEL SIÈGE DE TOILETTE