

# CAMRI

## TWO PIECE DUAL FLUSH HIGH EFFICIENCY TOILET TOILETTE DEUX PIÈCES HAUTE EFFICACITÉ



- **4720BLW** Lined Tank / Réservoir isolé
- **4720BLWU** Unlined Tank / Réservoir non-isolé

**4.8LPF / 1.28GPF OR (OU) 3.0LPF / 0.8GPF**

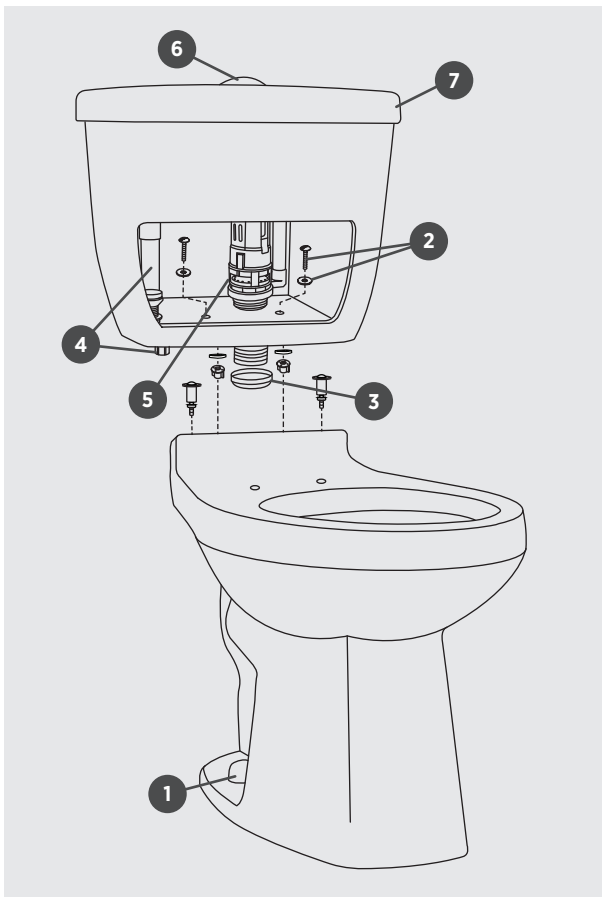

### ILLUSTRATED PARTS LIST | LISTE DE PIÈCES ILLUSTRÉE

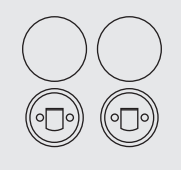
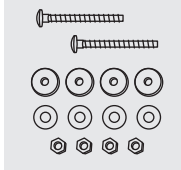

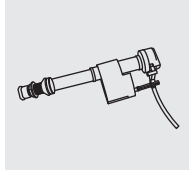
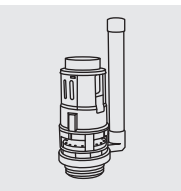
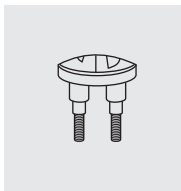
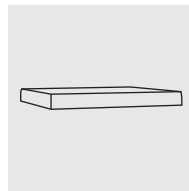
 <p><b>1  </b> PB-BOLT CAP SW-ZH090 <b>BOLT CAPS</b> BOUCHONS</p>	 <p><b>2  </b> PB-CONTRAC TANK-HW <b>TANK HARDWARE</b> MATÉRIEL DE RÉSERVOIR</p>	 <p><b>3  </b> PB-TOILET GASKET 3IN <b>TANK GASKET</b> JOINT DE RÉSERVOIR</p>	 <p><b>4  </b> PB-FILLV-RT-A1250 <b>FILL VALVE</b> ROBINET DE REMPLISSAGE</p>
 <p><b>5  </b> PB-FLUSHV-RT-A241703 <b>FLUSH VALVE</b> ROBINET DE CHASSE</p>	 <p><b>6  </b> PBC-PUSHLEVERA36131W <b>PUSH BUTTON</b> BOUTON-POUSSOIR</p>	 <p><b>7  </b> PB-4720BPW-H-T LID <b>TANK LID</b> COUVERCLE DU RÉSERVOIR</p>	

\*Toilet seat not included